

REAR TOP/BOTTOM  
NEED 2

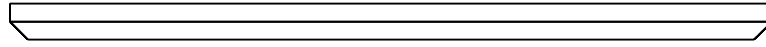

1"X1"  
CHECK  
SCALE

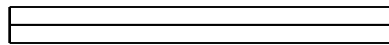

REAR  
UPRIGHTS  
NEED 2

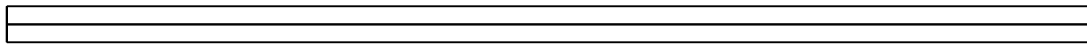

B PILLAR TOP

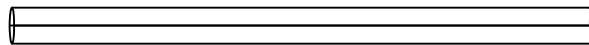

B PILLAR  
NEED 2



1"X1"  
CHECK  
SCALE

COCKPIT  
BELT LINE

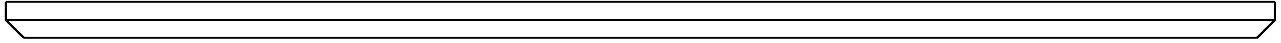

1"X1"  
CHECK  
SCALE

FLOOR

BASE

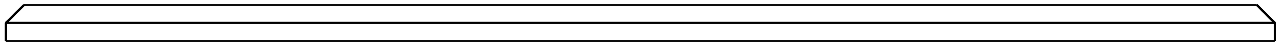

# REAR BELT LINE

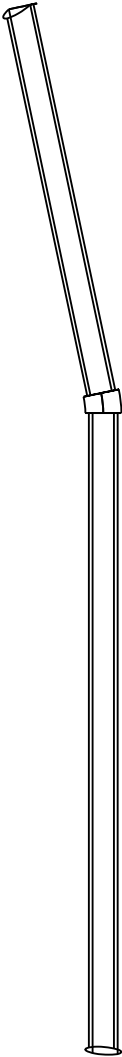
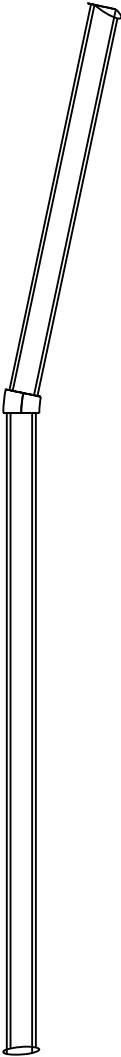

1 "X1 "  
CHECK  
SCALE

1"X1"  
CHECK  
SCALE

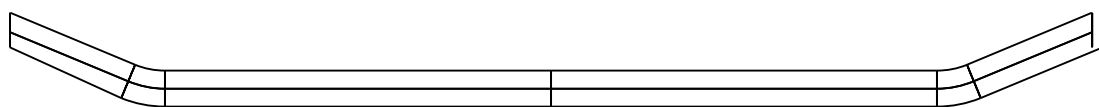

EYE BROW

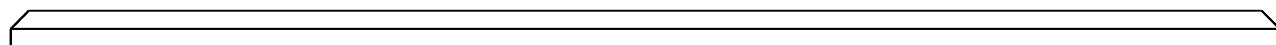

COWL BAR

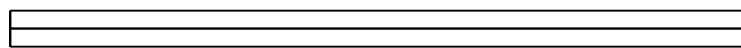

FRONT  
BUMPER BAR

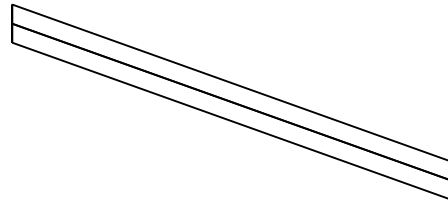

LOWER B

PILLAR

NEED 2

1"X1"  
CHECK  
SCALE

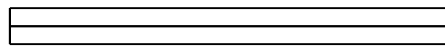

LOWER A

PILLAR

NEED 2

1" X 1"  
CHECK  
SCALE

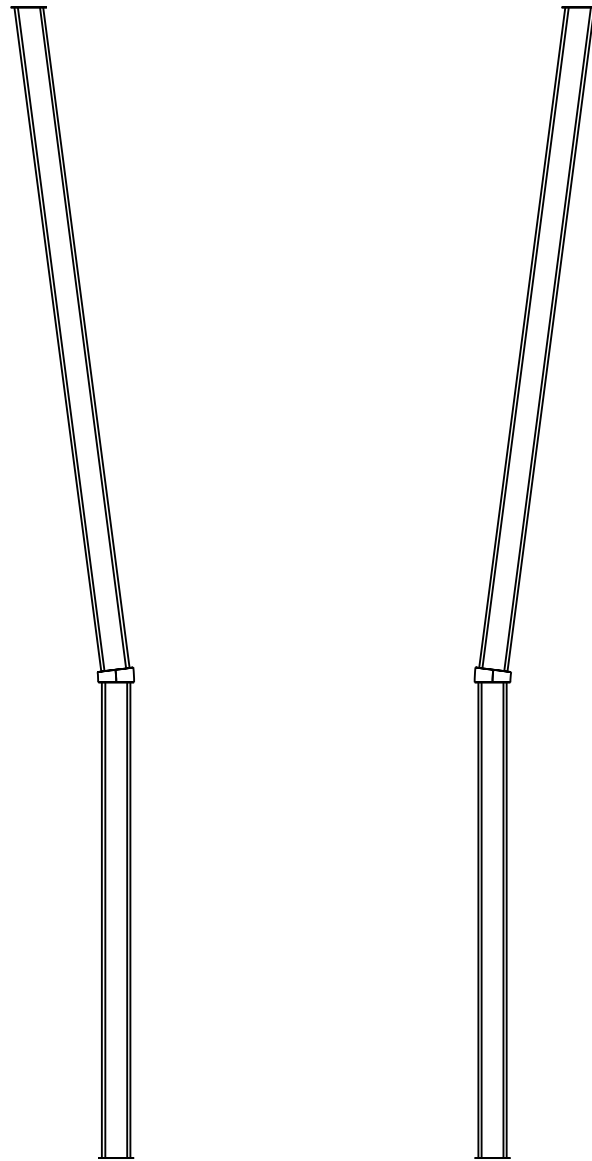

FRONT FRAME  
RAILS

# REAR FRAME RAILS

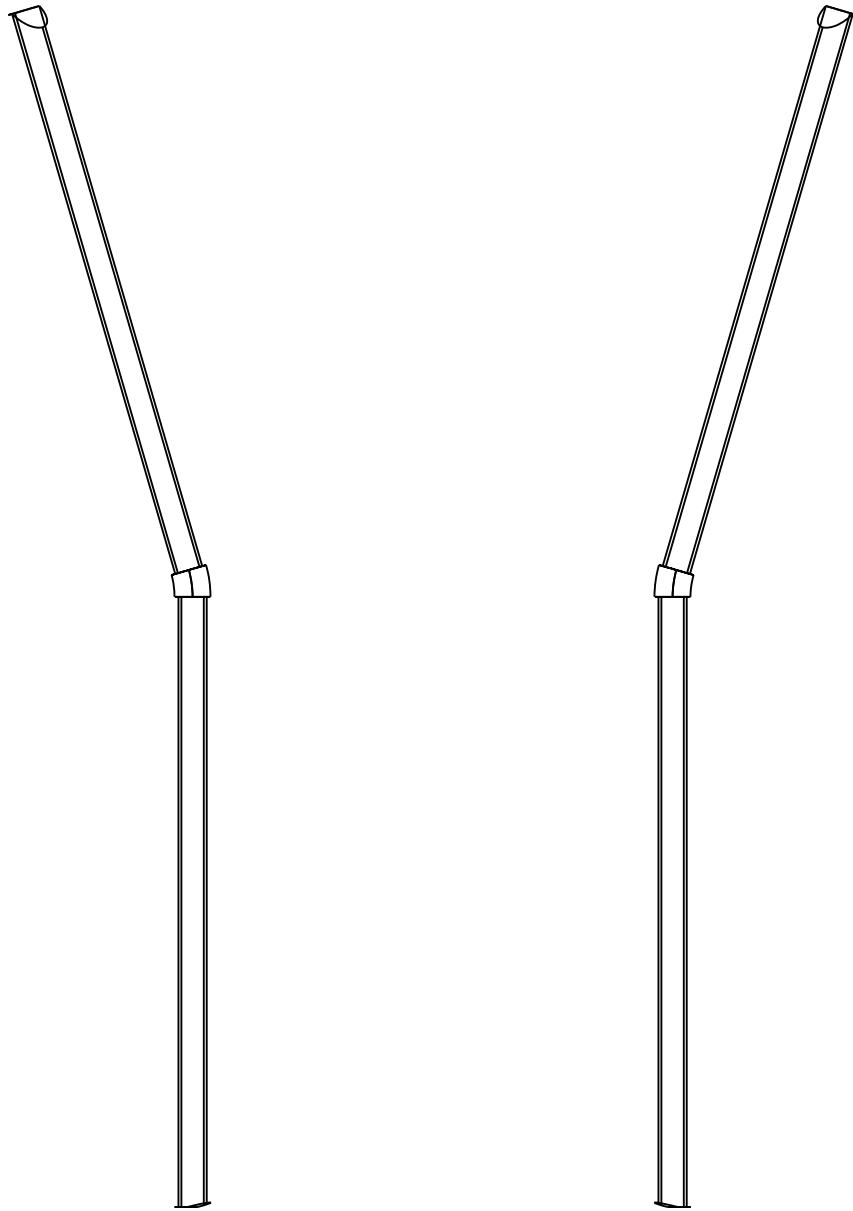

1" X 1"  
CHECK  
SCALE



UPPER FRONT  
FRAME RAIL  
NEED 2, MIRRORED

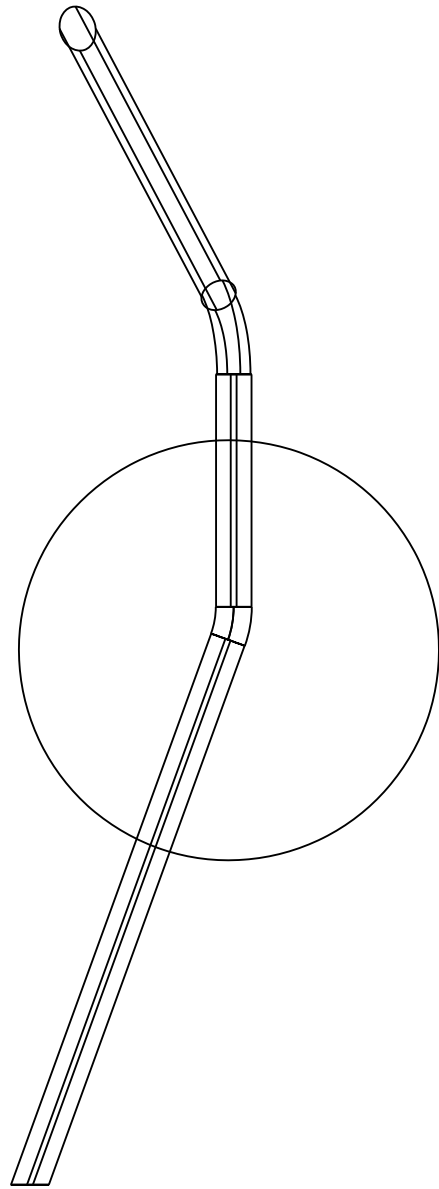
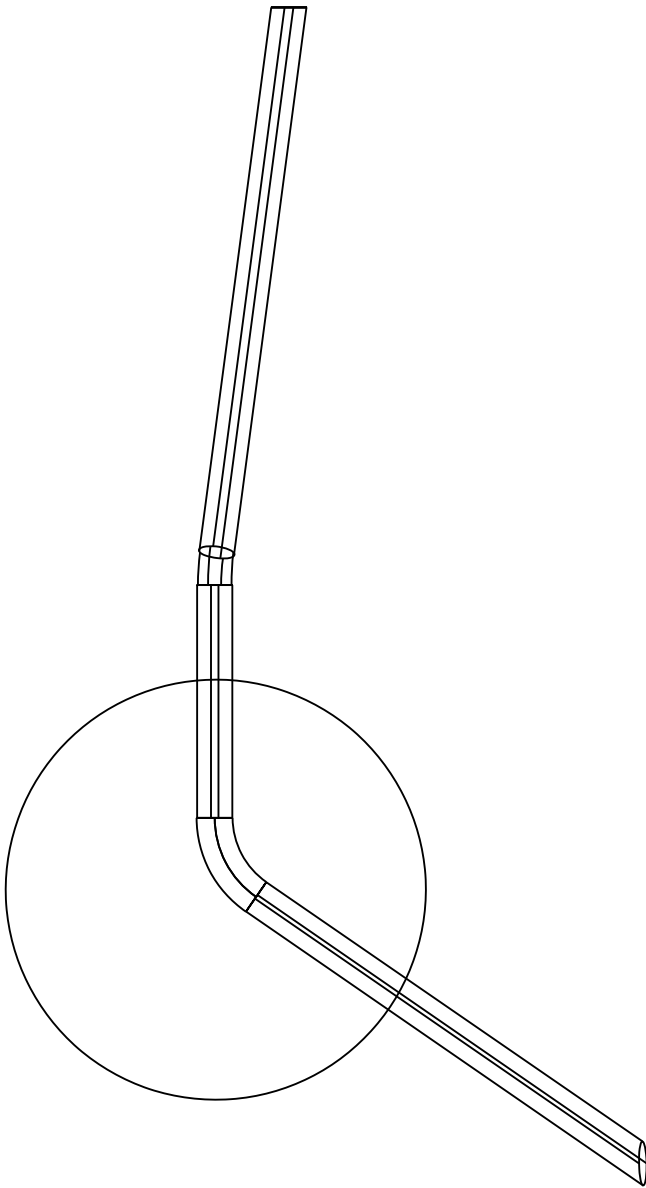

1"X1"  
CHECK  
SCALE

# HOOD BAR(S)

PAGE 2

1"X1"  
CHECK  
SCALE

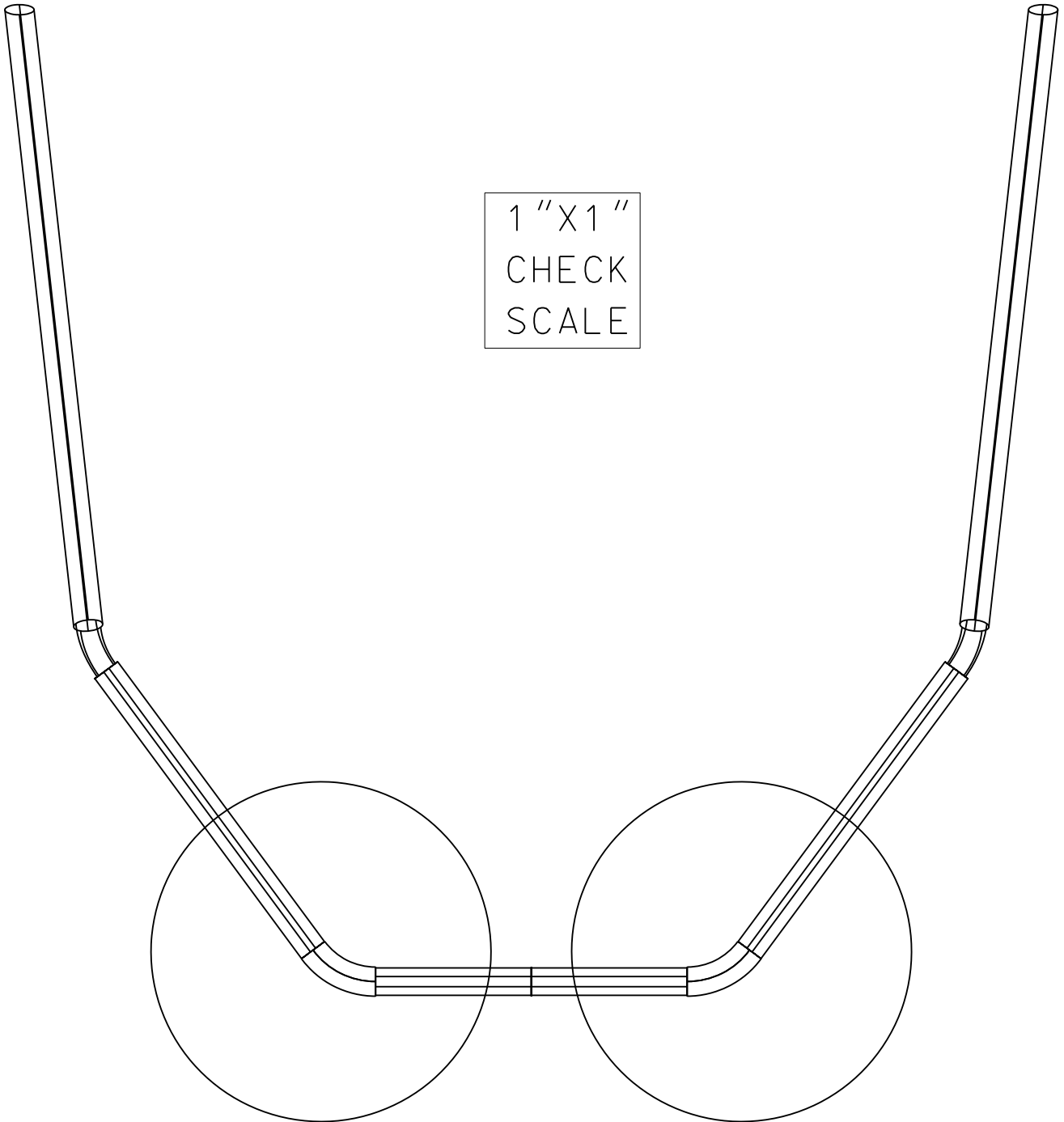

# HOOD BAR(S)

PAGE 2

1"X1"  
CHECK  
SCALE

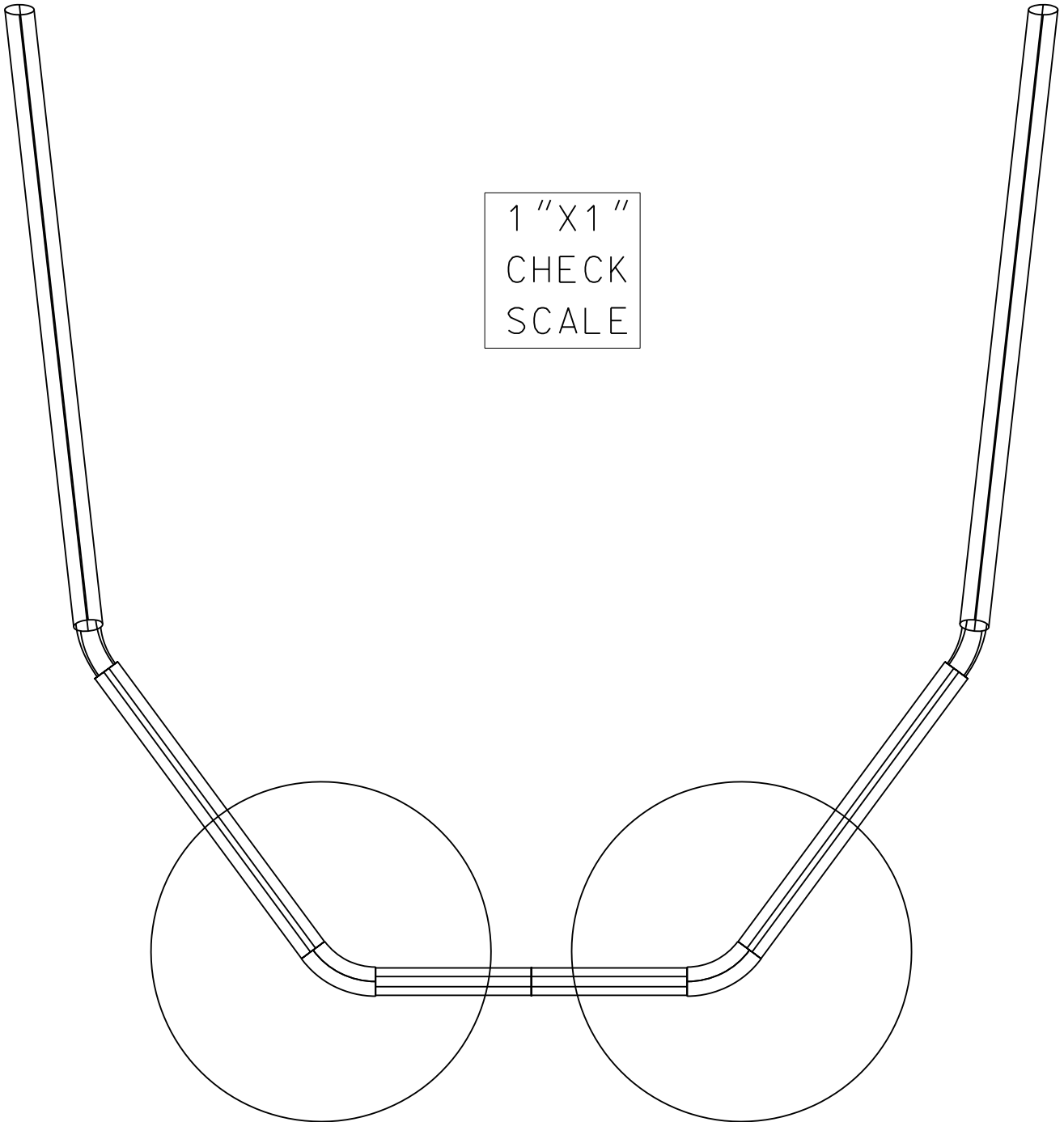

1 "X1 "  
CHECK  
SCALE

MATCH LINE

A TO C PILLAR  
BEND 1  
SHEET 1 OF 2

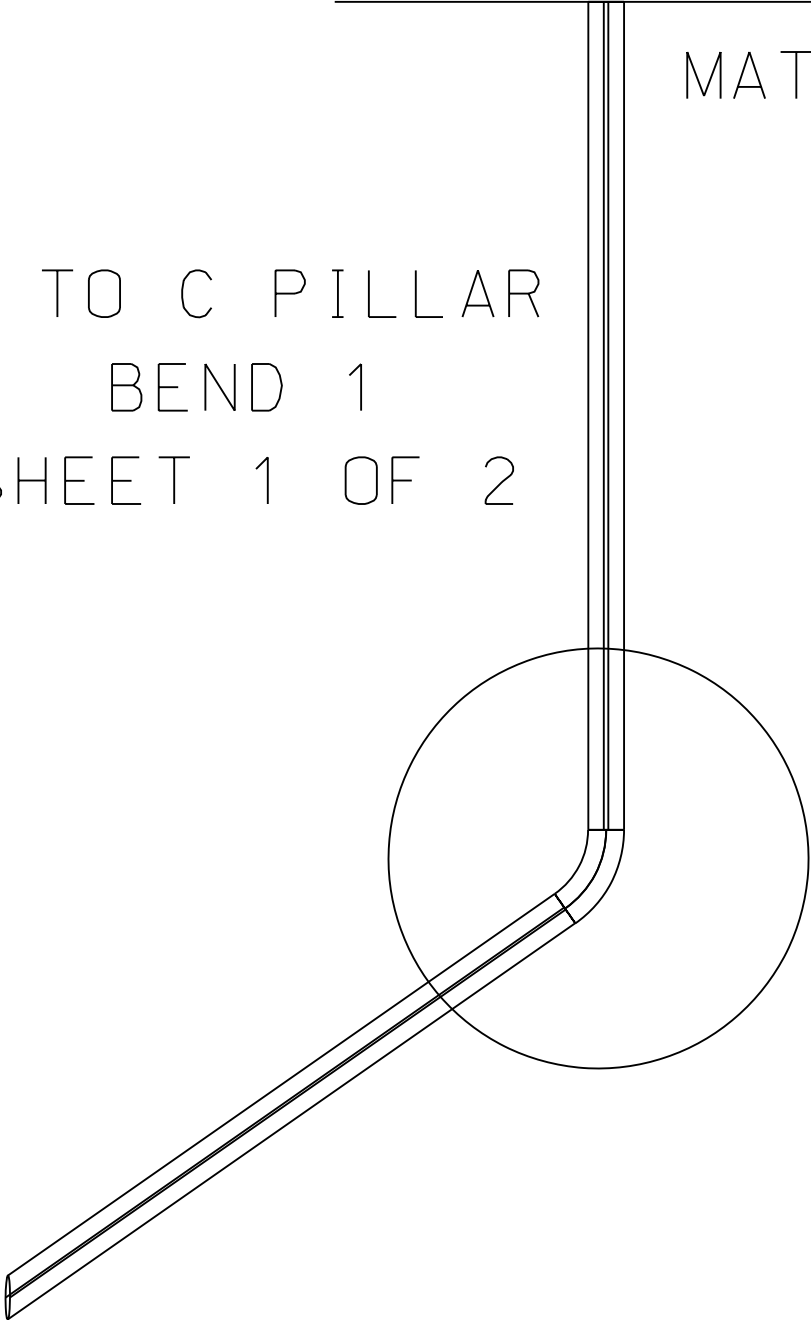

A TO C PILLAR  
BEND 1  
SHEET 2 OF 2

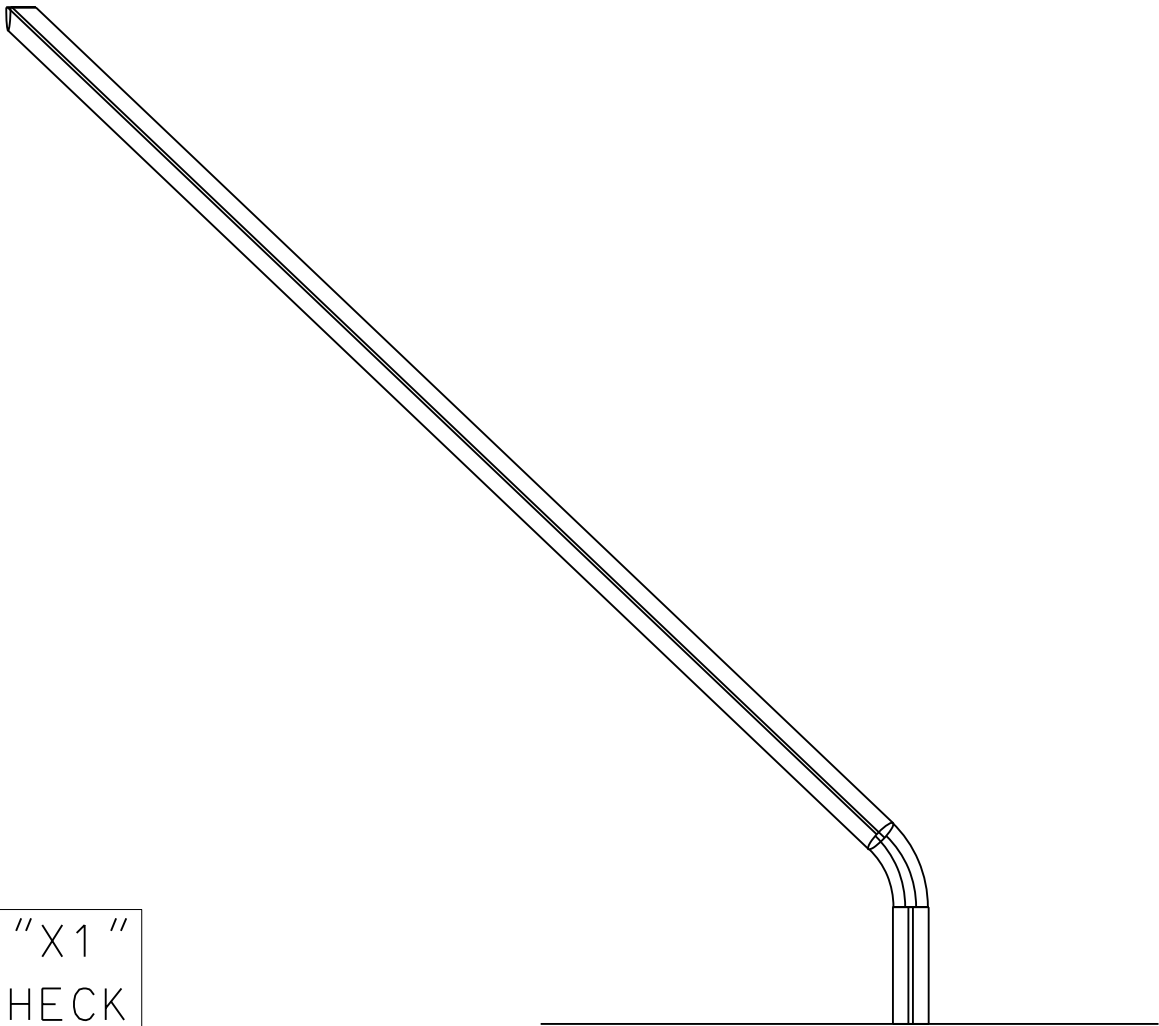

1"X1"  
CHECK  
SCALE

MATCH LINE

A TO C PILLAR  
BEND 2  
SHEET 1 OF 2

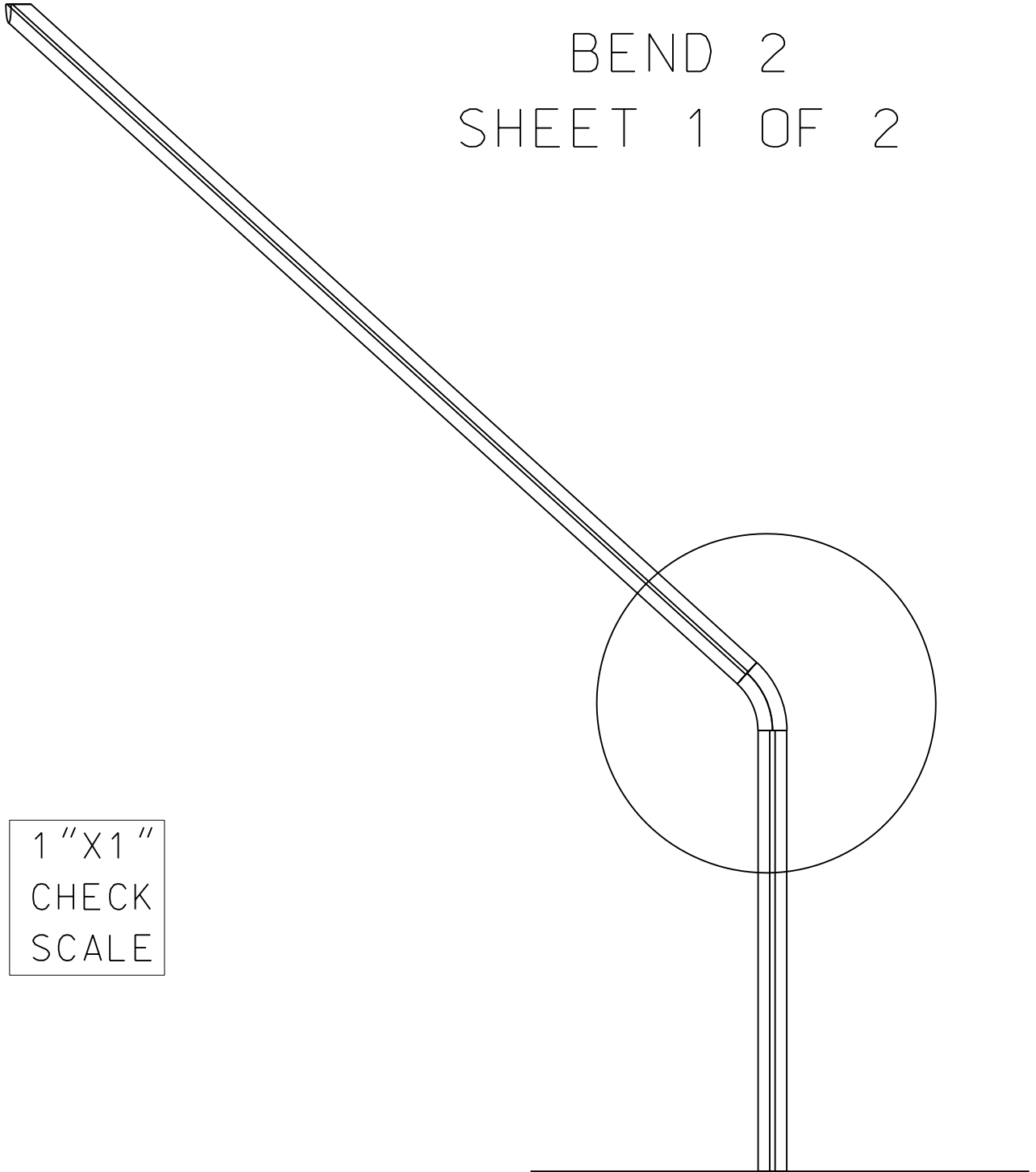

1" X 1"  
CHECK  
SCALE

MATCH LINE

1"X1"  
CHECK  
SCALE

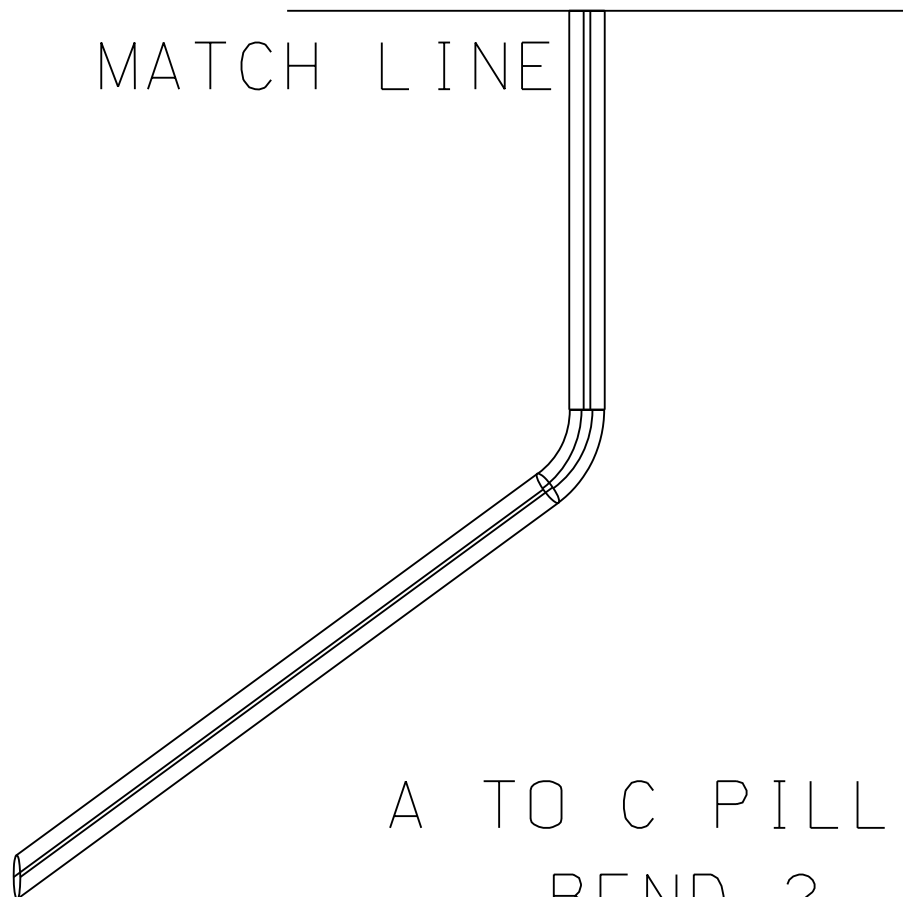

MATCH LINE

A TO C PILLAR  
BEND 2  
SHEET 2 OF 2

